

OWNER MANUAL

PLEASE SAVE THIS MANUAL
FOR FUTURE REFERENCE

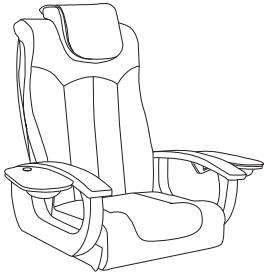

Chair 9622

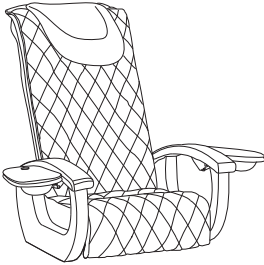

Chair 9620-1

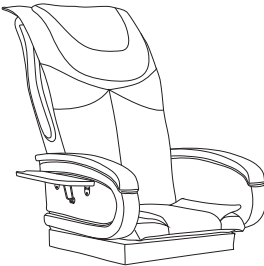

Chair 9640

La Fleur 3 FootSpa

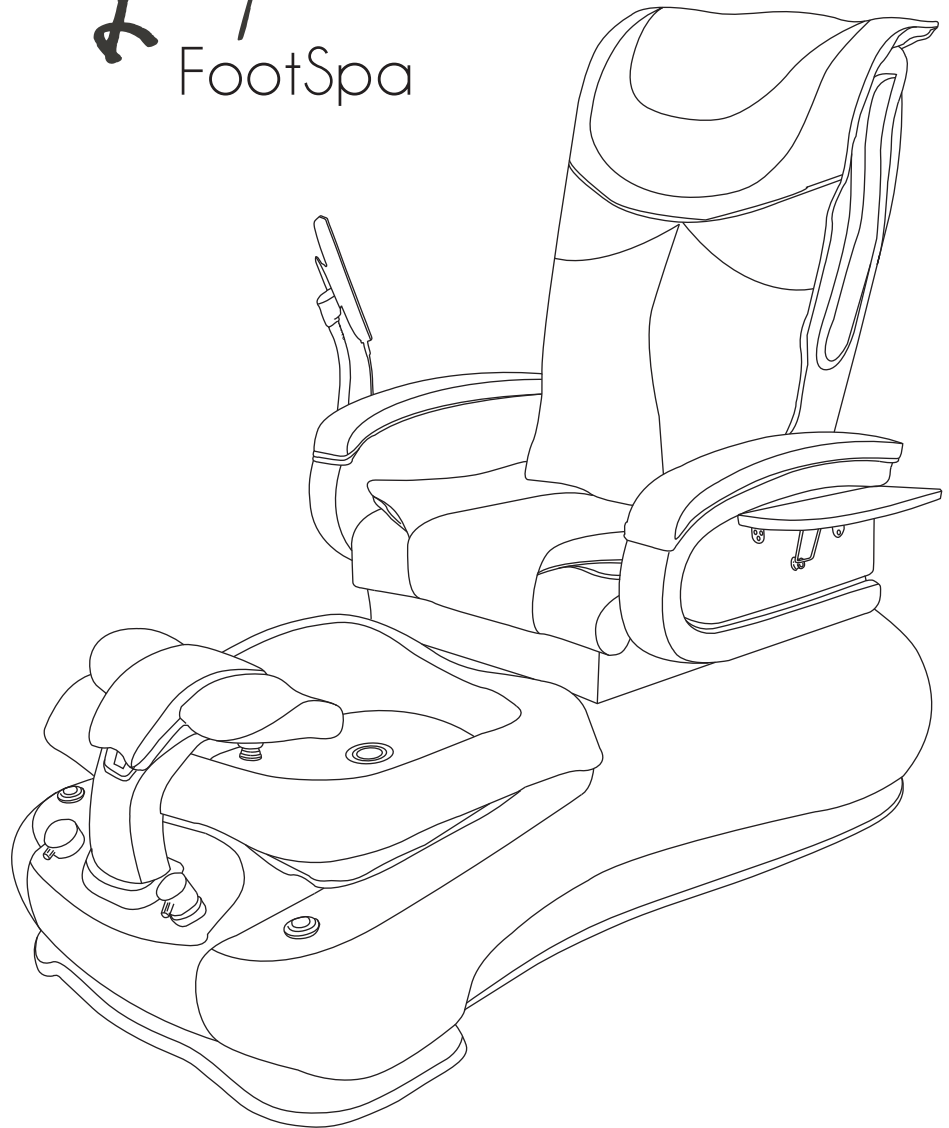

Table of Contents

Owner Manual

Safety and Precautions	1-2
Identifying Parts.....	3-4
Foot-Spa Clearance	5
 INSTALLATIONS	
Attaching Seat	6
Jet Assembly	7-8
Plumbing Connections	9-10
Operations and Use	11-12
Cleaning & Maintenance	13-14
Warranty & Service	15

Thank you for purchasing the La Fleur 3 spa from Gulfstream Inc. Please carefully read the instructions before installing the spa. Carefully follow the instructions and your spa will give you years of beauty and service.

This product is to be connected to a branch circuit outlet protected by a Class A GROUND FAULT CIRCUIT INTERRUPTER (GFCI), and the GFCI shall be tested regularly for continued protection and correct operation. If a Class A GFCI protected outlet is not available, **DO NOT USE THIS PRODUCT!** Please contact a licensed electrician for installation of a Class A GFCI according to local electric codes, or equivalent.

**Warning**

**THIS PRODUCT IS FOR INDOOR USE ONLY
DISCONNECT POWER SUPPLY CORD BEFORE SERVICING AND CLEANING**

The foot-spa must be installed by a licensed plumber and electrician in accordance with local codes. Plumbing and Electrical Installation instructions must be adhered to in order for the warranty to be in effect and to ensure the utmost in safety. The chair and spa have a maximum seating capacity of **350 pounds**.

The foot-spa is not intended to be stood in or used as a step. The portable foot-spa model is movable, standing in tub or using as a step may cause severe damage to the unit as well as possible serious injury to the person.

**Warning**

If a crack occurs in the glass bowl, **DO NOT** manually handle the bowl unless the proper attire is worn. Under no circumstances may the bowl be used by your customers as you could be held accountable for any injury that may occur. Gulfstream is not liable for any injury that may occur.

BASIC PRECAUTIONS SHOULD ALWAYS BE OBSERVED, INCLUDING THE FOLLOWING:

1. Read and follow all instructions
2. **DANGER.** To reduce the risk of injury, do not permit children to use this unit unless they are supervised at all times
3. Use this unit only for its intended use as described in this manual. Do not use attachments that are not recommended by the manufacturer.
4. Never drop or insert any object into any opening.
5. Do not block jets during whirlpool operation.
6. The unit must be connected to an electrical supply circuit that is protected by a ground fault circuit interrupter.
7. The clean jet motor is magnetically driven and is insulated twice. Therefore, it does not require to be bonded.
Save these instructions

**Warning**

1. Excessive water temperature is dangerous and should be checked **BEFORE** using.
2. The maximum temperature of the water should never exceed 100 degrees F.
3. Always enter and exit the Foot Spa slowly and carefully.
4. **NEVER** bring and / or operate any electrical devices into or near the Foot Spa.
5. **NEVER** run the pump (Jet/Motor) unless the pump body fully submerged in water.
Water level in the bowl to be above the top of Jet body.
DO NOT Run Jet dry.

GROUNDING METHODS

Because this unit must be connected to a circuit with a ground-fault circuit interrupter (GFCI), DO NOT use a grounding adapter.

The use of a grounding adapter is prohibited in Canada by Part I of the Canadian Electrical Code.

GROUNDING INSTRUCTIONS

This appliance must be plugged into an outlet equipped with a ground-fault circuit interrupter. The ground-fault interrupter can be in the outlet shown in illustration A or in the circuit breaker (fuse) box. If your outlet or circuit breaker (fuse) box is not equipped with a ground-fault interrupter, you must have your electrician install one (5 amps/unit required).

In the event of an electrical short-circuit, the ground-fault circuit interrupter will turn off the electrical power to the unit immediately, greatly reducing the likelihood of serious injury. This appliance is for use with a nominal 120-volt circuit and has a grounding plug that looks like the plug illustrated in the sketch. The outlet must be properly installed and grounded in compliance with all local codes and ordinances.

If it is necessary to use an extension cord, use only a three-wire extension cord that has a three-blade grounding plug and a three-slot receptacle that will accept the plug on the appliance.

Replace any damaged cord.

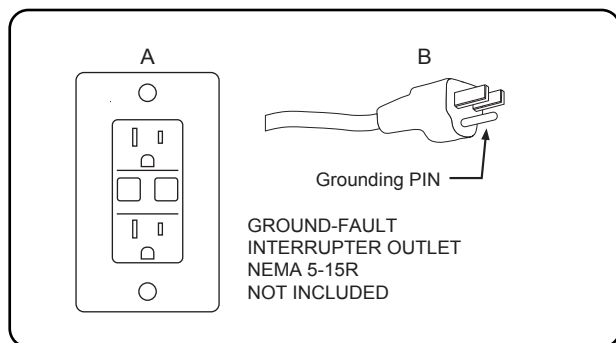

COMPLIANCE WITH LOCAL CODES AND/OR INSPECTIONS IS THE RESPONSIBILITY OF THE PURCHASER AND/OR INSTALLER.

OPERATION AND USE INSTRUCTIONS, (READ AND FOLLOW ALL INSTRUCTIONS)



Warning

IMPORTANT! At the end of the day, **ALWAYS** turn the main power OFF! including the power switch on the chair.

1. **DANGER:** To reduce the risk of injury, do not permit children to use this unit unless they are closely supervised at all times.
2. **CAUTION:** This unit should not be used by persons with open wounds, cuts or sores on their feet or legs, or by persons with poor circulation, or by persons with heart conditions. If in doubt, the client should consult with his or her physician.
3. Use this unit only for its intended use as described in this manual. Do not use attachments not recommended by the manufacturer
4. Do not operate with a damaged cord or plug. If unit malfunctions or is damaged in any manner, contact an authorized service representative for examination or repair.
5. Never drop or insert any objects into any opening.
6. Do not block jets during pedicure operation.
7. Water temperature should be checked before use. Water temperature should never exceed 100 degrees Fahrenheit.
8. Never bring any electrical devices into the unit or operate electrical devices near it.
9. The unit must be connected to a supply circuit that is protected by a ground-fault circuit interrupter (GFCI).
10. Connect the unit only to a properly grounded outlet. See grounding instructions.
11. Close supervision is necessary when the unit is used by, on or near children or invalids.

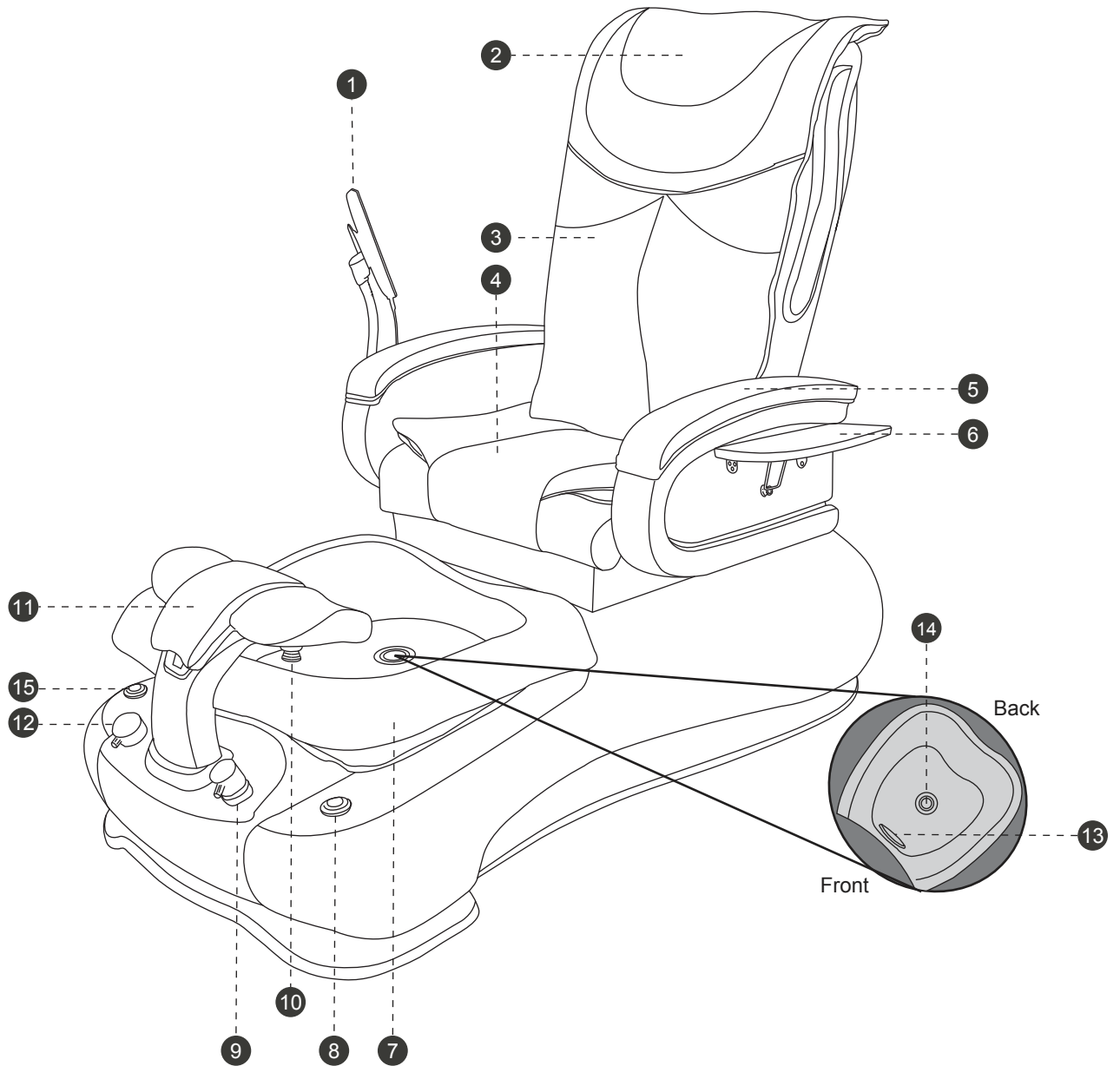

- | | |
|--|---|
| <ol style="list-style-type: none"> 1. Chair Remote Control 2. Headrest Pillow 3. Back Cushion & Massage 4. Seat Cushion 5. Wooden Armrest 6. Flip-up Manicure Tray
(Swing-out Accessories Bowl Access is available in the 9622 and 9620-1 chairs.) | <ol style="list-style-type: none"> 7. Glass Bowl 8. Jet Control (ON/OFF) 9. Water Mixer Control 10. Hand Spray under Footrest 11. Adjustable Footrest 12. Drain Control 13. Jet Mount 14. Drain 15. Discharge Pump Switch (Optional) |
|--|---|

SEAT OPERATION

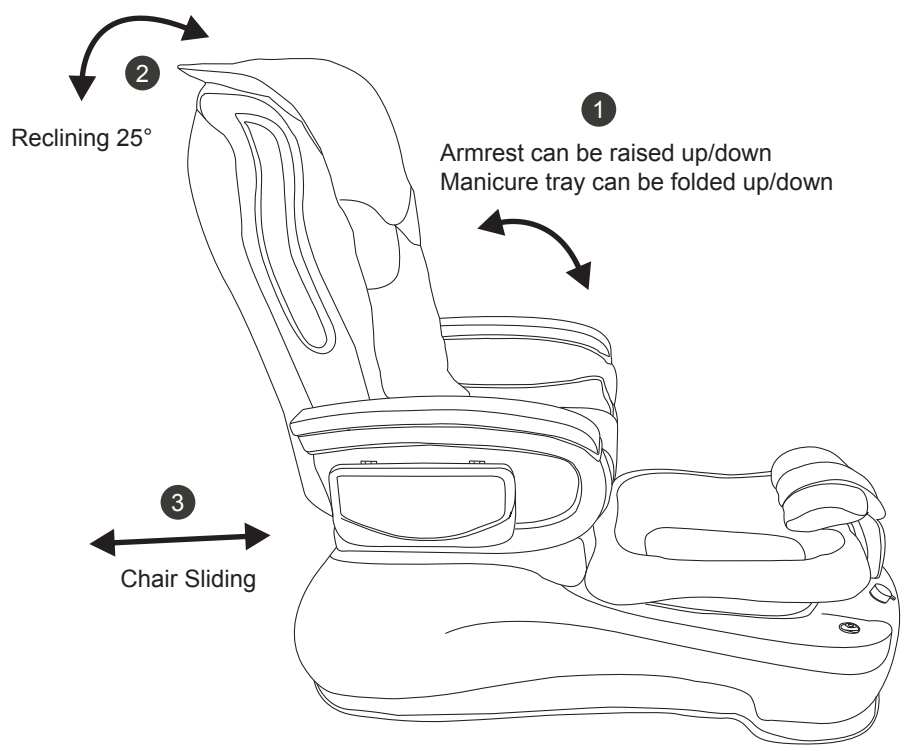

SPA DIMENSION

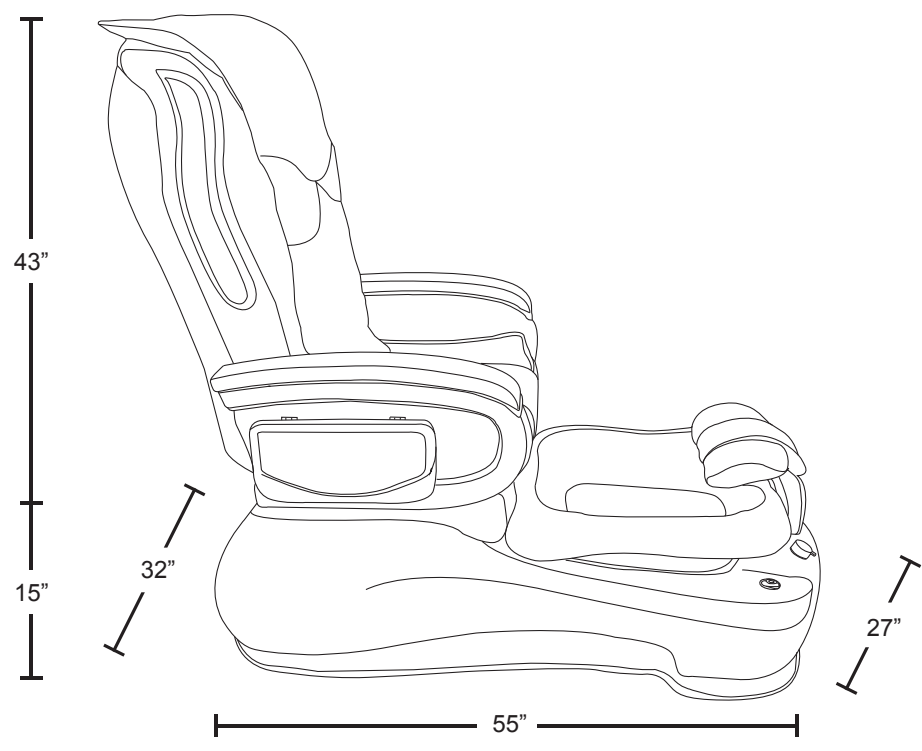

WALL CLEARANCE

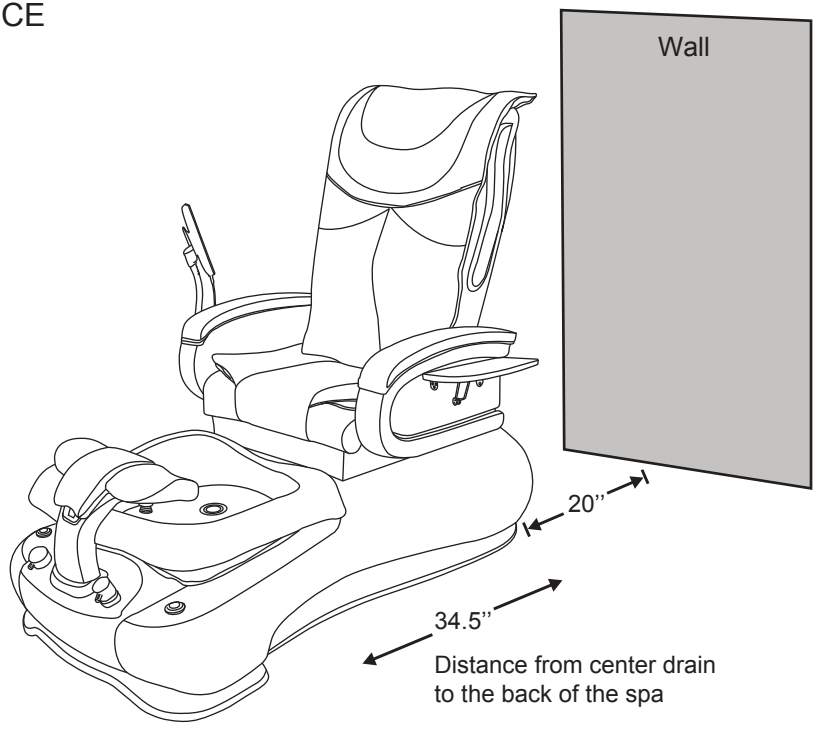

TYPICAL FOOT-SPAS

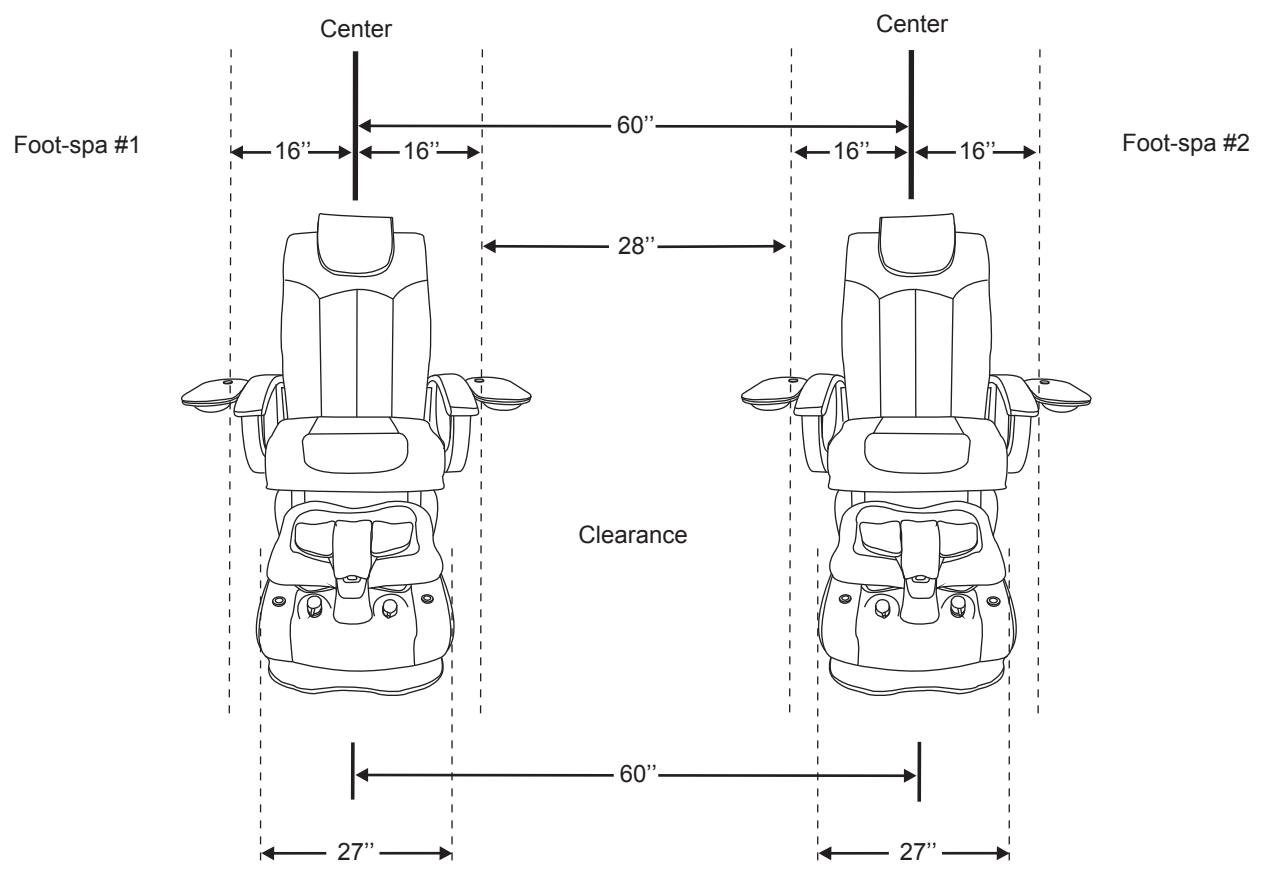

Attaching The Seat to The Base

Align the seat with the pre-drilled holes on the base then tightly secure with the nuts and bolts provided.

Attach trays or remote stand to armrest with screws provided.

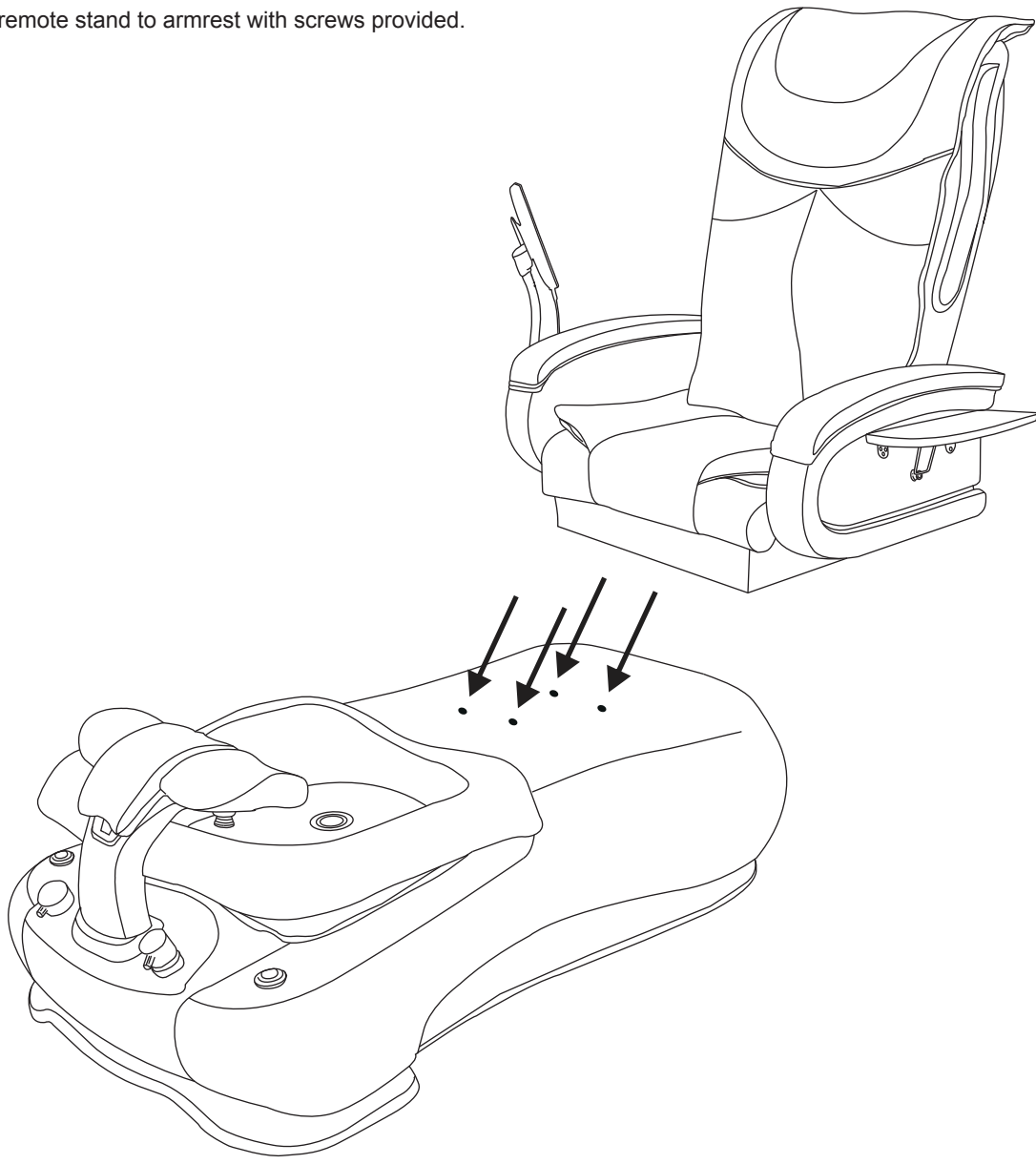

Cleanjet Unit Removal

To remove the jet unit from tub/bowl.
Gently pull out the jet unit from the anchor pegs

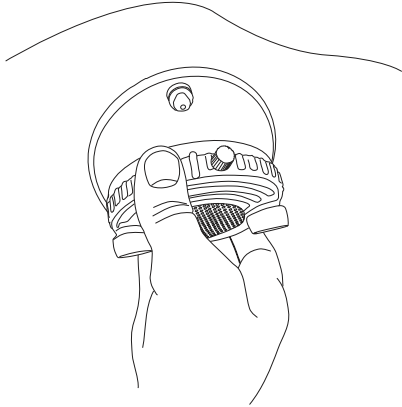

To remove the jet unit components. Pull-out Banana Plug then turn the top plate counter-clockwise in the arrow direction

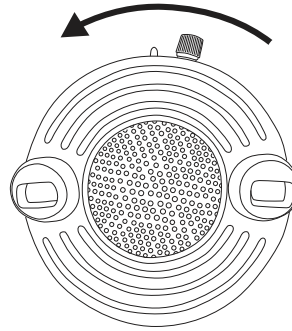

Jet Unit Components

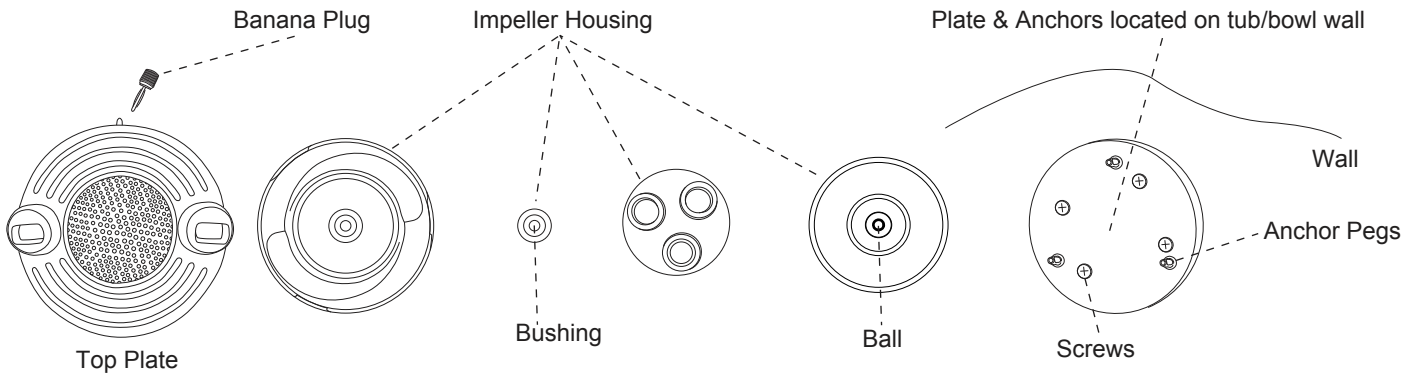

To install the jet unit. Assemble all jet unit components in order as before removal, snap the jet unit onto the anchor pegs located on tub/bowl wall securely.

Note: All jet unit components must be assembled in sequence of order to avoid malfunction.

Please call manufacturer for repair or replacement

Poly Liner Installation

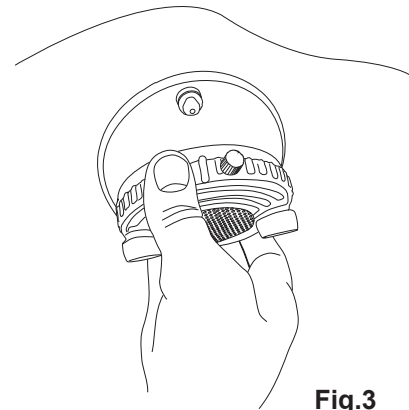
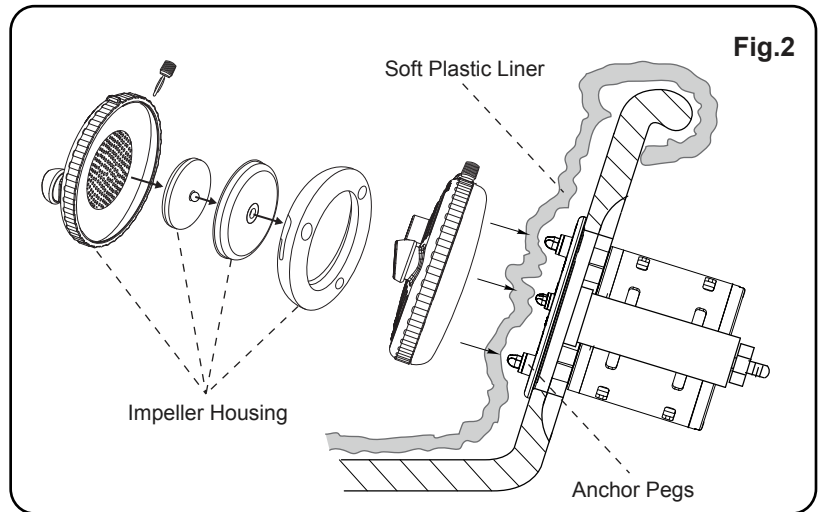
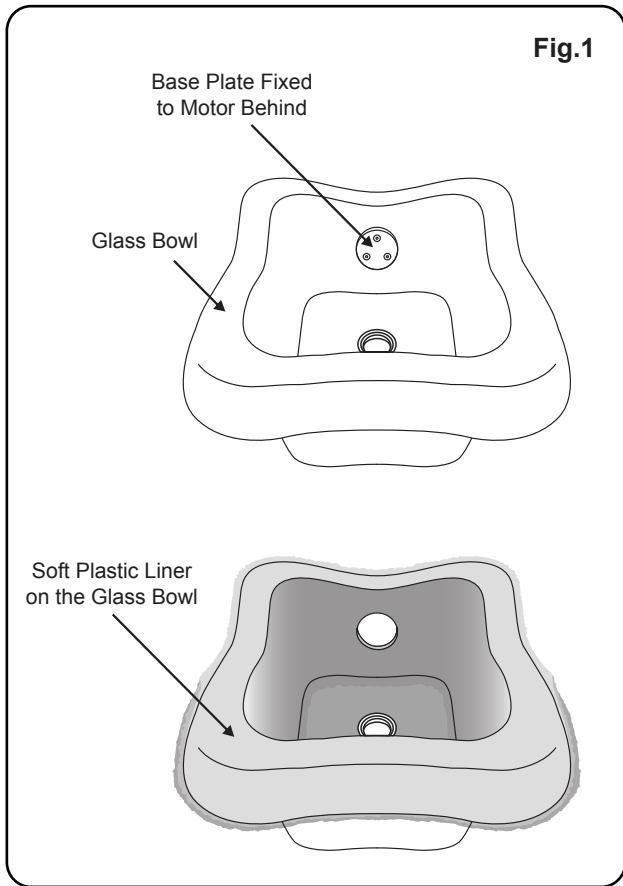

Fit elastic edge over bowl rim and form liner to bowl contours as shown in the Fig.1

Align the impeller unit onto the anchor pegs and push it onto the base plate as shown in Fig.2

To remove, gently pull the impeller unit as shown in Fig.3 from the base plate and pierce liner over drain, then once drained, pull up the plastic liner.

To avoid risk of infection disease, discard the liner after each use.

Plumbing Connections

1. Discharge pump may be connected to an existing sink drain or floor drain. It can also pump up to 7 ft high, but this will increase the length of the drain time. The drain connection is at the rear of the unit by a 3/4" fitting.
2. Gravity drain uses a standard gravity drain. A floor drain is recommended. P-Trap is not installed nor supplied. The floor drain should already have a P-Trap and the UPC codes do not allow double P-Traps in the system.
3. Hot and cold water supply connections are located at the rear of the unit (1/2" fittings). Please be advised that the hot and cold water supply lines are not fitted with optional back flow Preventers unless ordered at initial sale.
4. Have a qualified licensed electrician to install the wiring according to local codes. The Cleanjets are 1/18 HP, 120V A.C., 0.55 AMP. 60HZ. GFI protected circuit must be used to supply power to the unit. The roller back massage chair uses a 115V A.C. supply.
5. Spa base should be anchored securely to the floor. The base may be anchored through the opening in the back of the base wherever access is convenient for the installer.
6. Hand held sprayer is Model ST700.20. It has complied with applicable requirements of ASME A112.18.1-2005/CSA B125.1-05

FAILURE TO ANCHOR THE BASE MAY RESULT IN PERSONAL INJURY OR DAMAGE TO THE UNIT. DAMAGE AS A RESULT WILL VOID THE WARRANTY.

Typical Gravity Sink (Direct Drain) Installation

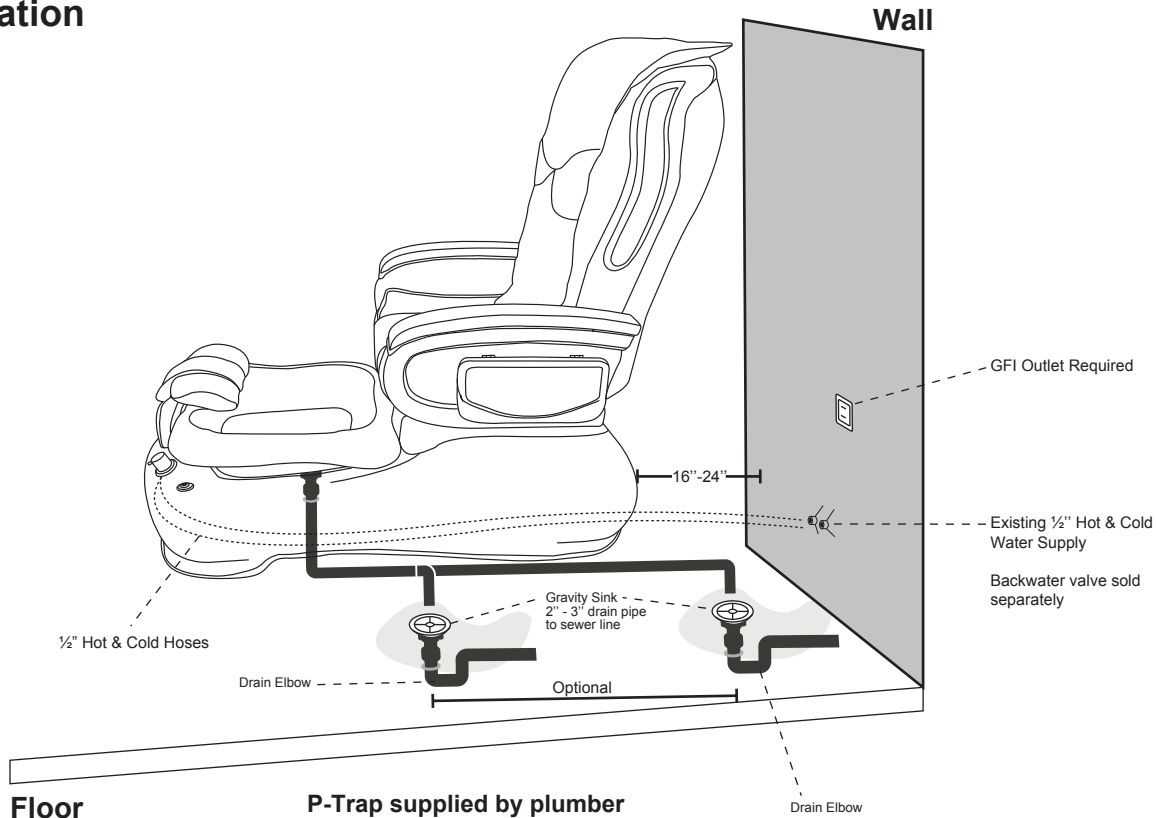

Typical Discharge Pump Installation

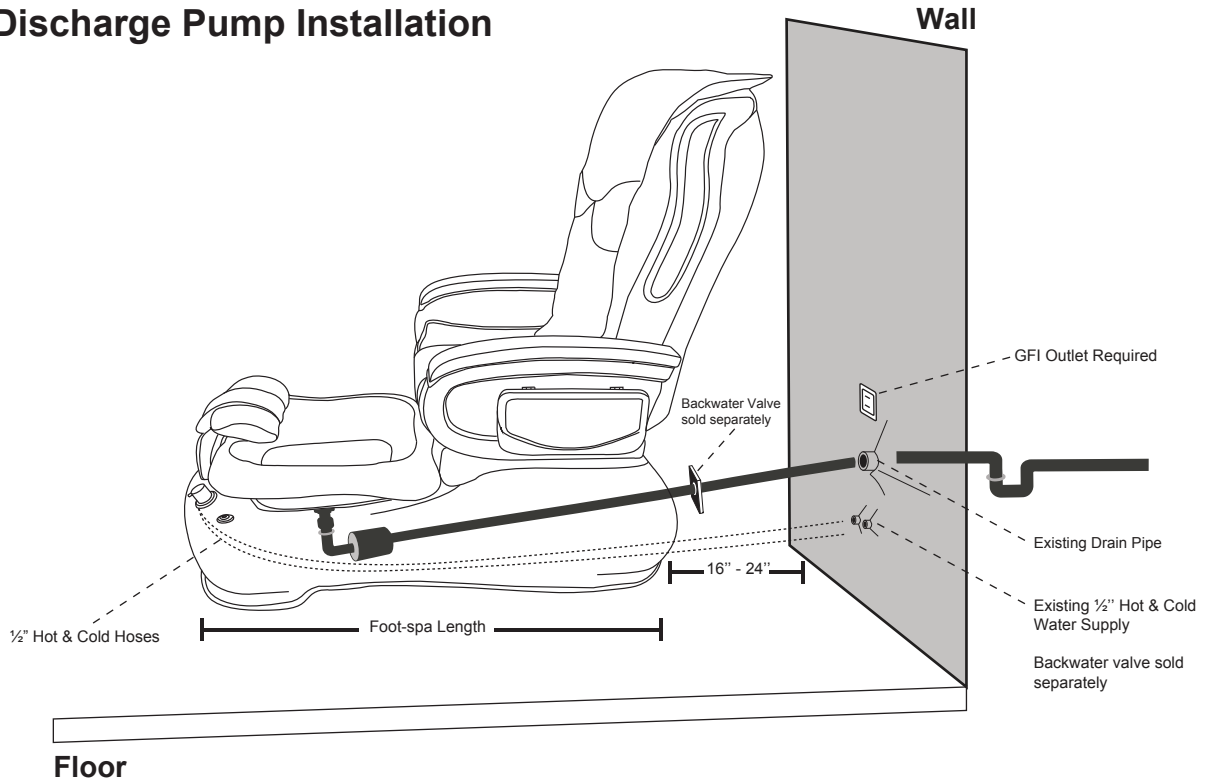

Typical Gravity Sink (Direct Drain) Installation

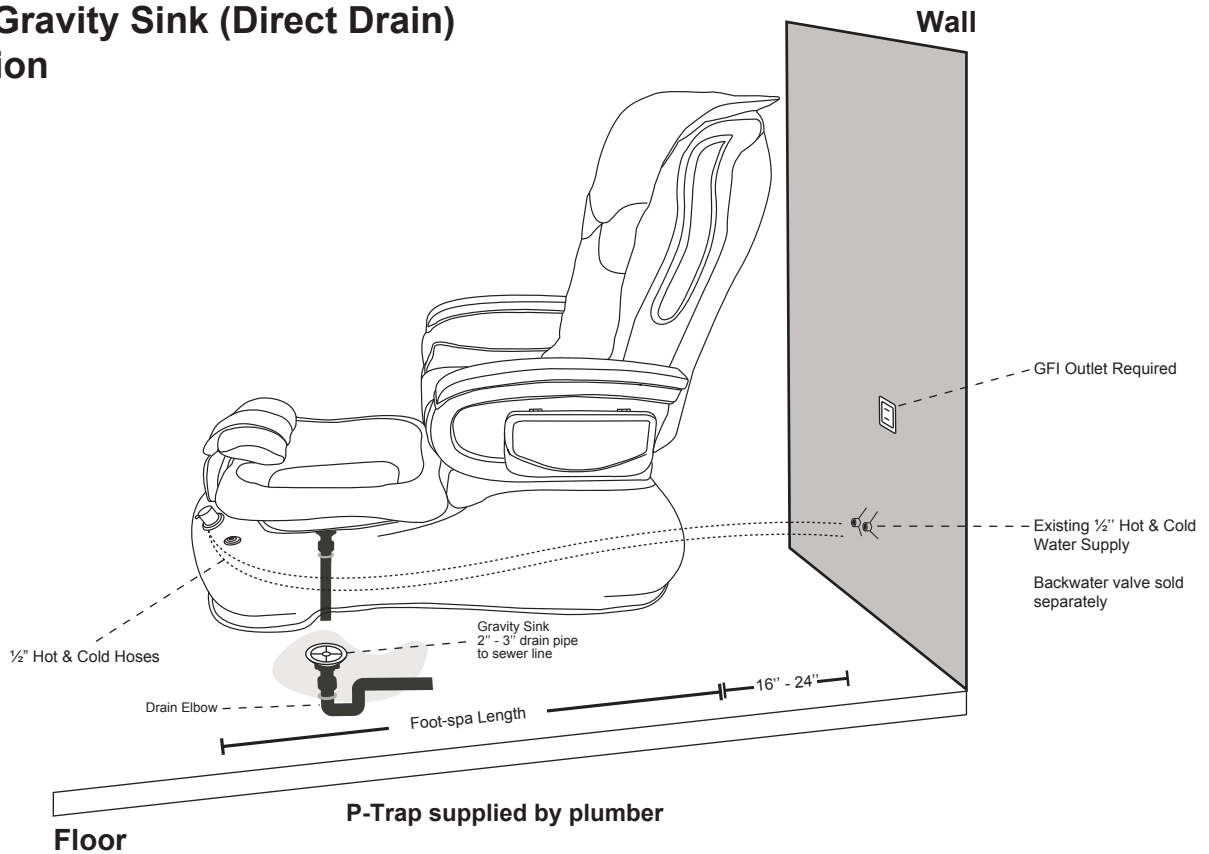

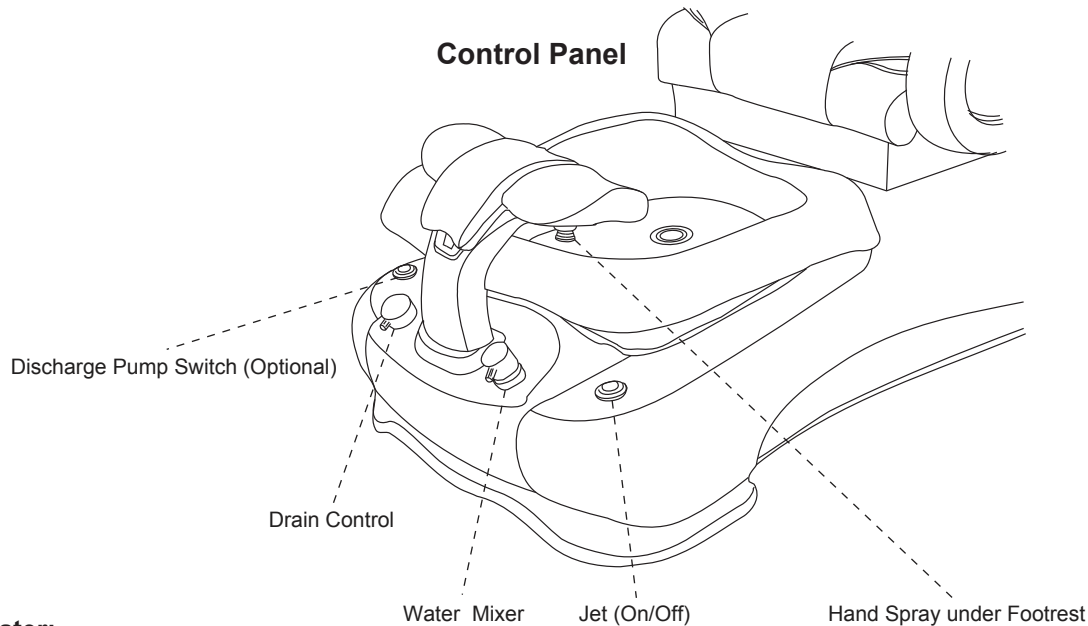

1. **To fill water:**

The foot-spa is provided with a single hot and cold mixing valve located on the front of your spa. This is a pressure balance valve that requires you to lift the handle to start the water flow and to adjust to the temperature that is desired. The clean jet body must be completely submerged in water.

CAUTION: DO NOT USE FOAMING, SUDSING OR MINERAL OIL BASED ADDITIVES IN THE WATER.

2. **To start whirlpool:**

Press the button as shown. This will start your Clean Jet motor. You may stop the whirlpool function at any time by pressing the button again.

3. **To drain Footspa bowl:**

Turn drain control knob to "pop-up" drain plug.

- If gravity drain (no discharge pump); water in bowl empties with duration determined by waste water plumbing characteristics.
- If optional discharge pump has been installed; then press discharge pump button to activate 2-minute timer controlled pump. Average drain time approximately one minute (depending on plumbing characteristics).

4. The Shiatsu Roller back massage Chairs are equipped with a state-of-the-art robotic massage system.

This system is easy to use. The remote has a one-touch power button that initiates a pre-programmed massage session. Various massage functions are also available for selection via this remote. The chair's position can also be adjusted; forward/backward as well as reclined to the client's preference (see illustrations on page 12).

Note: Read and Follow Chair Manual Instructions

BASIC PRECAUTIONS SHOULD ALWAYS BE OBSERVED, INCLUDING THE FOLLOWING:

1. Read and follow all instructions
 2. **DANGER.** To reduce the risk of injury, do not permit children to use this unit unless they are supervised at all times.
 3. Use this unit only for its intended use as described in this manual. Do not use attachments that are not recommended by the manufacturer.
 4. Never drop or insert any object into any opening.
 5. Do not block jets during whirlpool operation.
 6. The unit must be connected to an electrical supply circuit that is protected by a ground fault circuit interrupter.
 7. The clean jet motor is magnetically driven and is insulated twice. Therefore it does not require to be bonded.
- Save these instructions

Shiatsu Remote Control

Please refer to instruction manual for operations

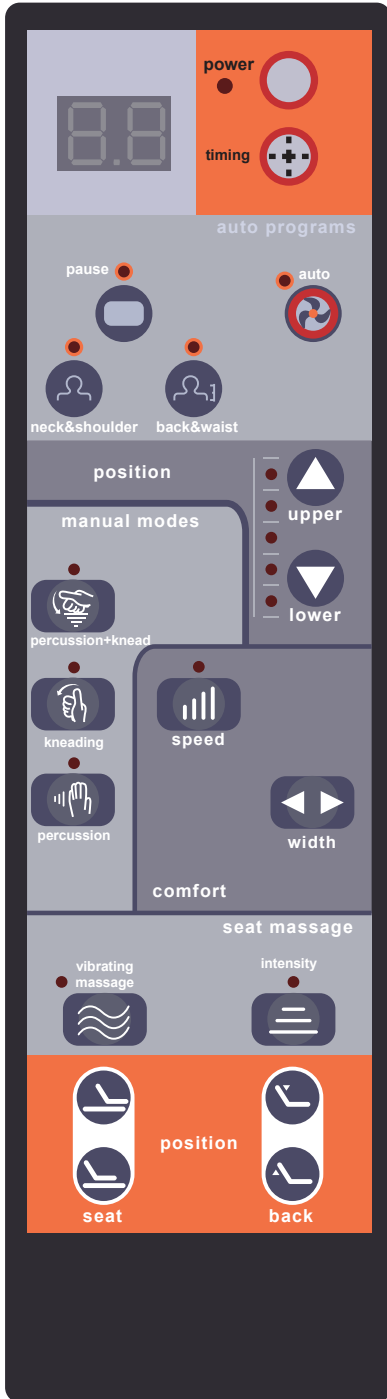

9620-1 / 9622



9640

Please refer the diagrams to remove jet covers for cleaning

Gulfstream Inc. highly recommends the following cleaning regimen. You should always contact your local governing agency for their specific cleaning and disinfecting requirements and regulations for pedicure spas. For your clients safety, always use the regulations as a minimum standard for cleaning and disinfecting. Combining your states standards with the regimen listed below will provide your clients with a safe and healthy pedicure spa environment experience.

Routine maintenance:

Powdered cleansers or abrasives are **NOT RECOMMENDED**. A clean towel or sponge, are all that are usually needed. A soft bristled brush may be used when excessive residue is present. Use a mild soap and water solution to clean the upholstery, but do not over wet. Wipe dry with a clean towel. No internal maintenance of the spa components are necessary. Remove clean jet caps and spray with disinfectant after each use. For extra protection, our recommendation is that the system be flushed daily or weekly depending on use. To flush the clean jet system fill the spa with hot water to just above the jets. Add disinfectant. Run whirlpool for 15 minutes, drain and then wipe dry with clean soft cloth.

NOTE:

Cleaning or sanitizing is NOT disinfecting. According to the Centers for Disease Control and Prevention (CDC), and the US Environmental Protection Agency (EPA), disinfecting occurs only when there is a reduction of pathogenic microbes at 99.999%. Sanitizing is only a reduction of 99.9%. Cleaning of whirlpool pedicure spas requires surfactant and chelating detergents that are low-foaming and have the ability to remove body oils, organic oil additives, mineral oil, skin cells, nail clippings etc. that can accumulate both in the basin and the jets which may become a fertile area for micro organisms to grow.

The use of oil based products can build up in the whirlpool system, causing clogging in the jets. Adherence to the above cleaning will minimize build up. Gulfstream Inc. does not recommend the use of mineral oil based products.

TESTING/FLUSHING FOOT SPA

After the foot spa has been installed, fill tub with water just above the jets. Carefully check for leaks at the drain and motor mount. After checking underside for leaks, turn on system by pushing whirlpool button and watch for leaks as water circulates. Let tub run full cycle. Open drain plug for water discharge.

Cleaning The Magnet Jet (Step by Step)



Warning

- Do not run Cleanjet® MAX without water. This will **void** your warranty
- Do not place two wet ends in the same bowl when cleaning the jet's strong magnets could cause **injury** (pins your fingers)
- Do not attach two wet ends to each other. Doing so will cause breakage to wet ends and will **void** the warranty

Magnet Jet Components

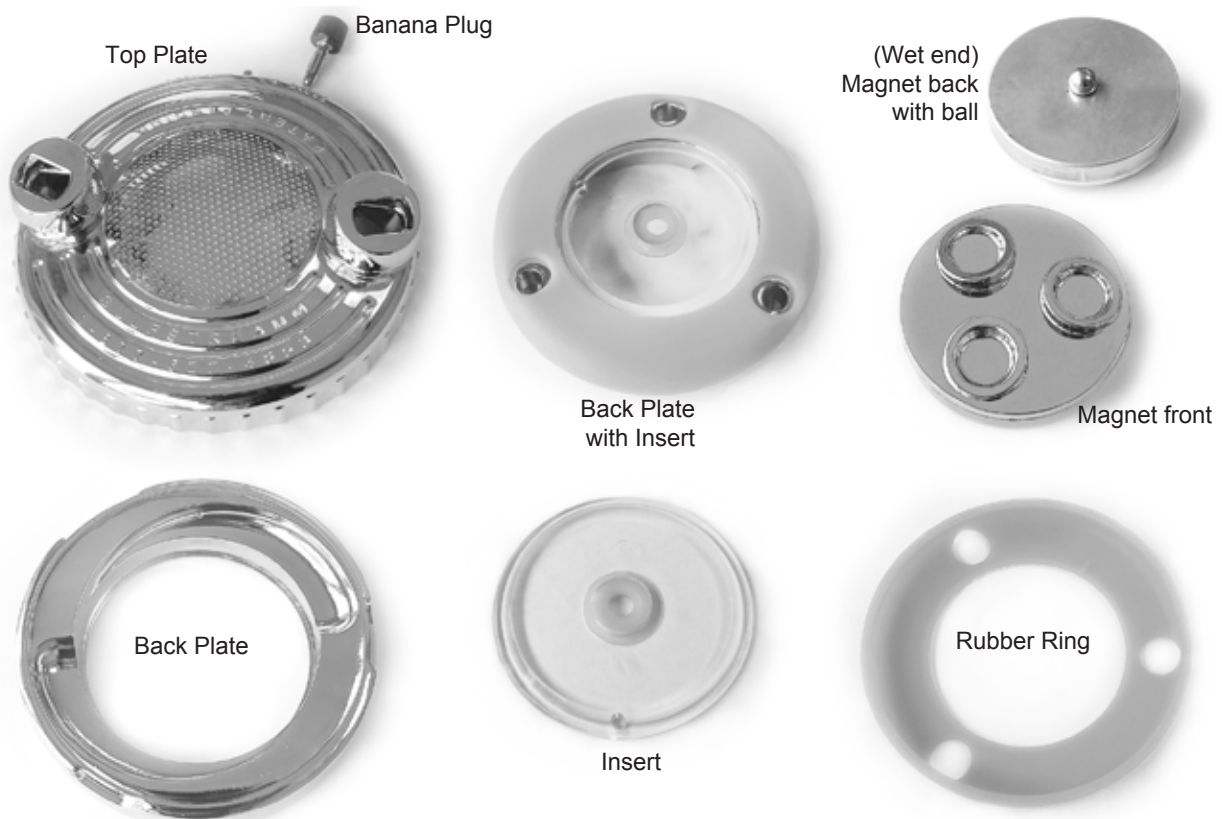

1. Pull Magnet Jet Cap off from the Retainer Plate in the pedicure bowl.
2. Remove blackheaded banana plug from outside rim.
3. Turn the Top Cover off the Magnetic Jet Cap counter-clockwise.
4. Separate the three components of the Magnetic Jet Cap: Top Cover, Magnet and Back Cover.
5. Wash each component of the Magnetic Jet Cap in a recommended or high quality solution or cleaning agent.
6. Reassemble the Magnet Jet Cap using the following directions:
 - Put the Magnet, with the three circles facing upwards, in the center of the Back Cover.
 - Take Top Cover and place over Magnet, offset pre-drilled holes on the outer edge, twist Top Cover, clockwise with Back Cover until holes are aligned, push in banana plug.
 - Remount the Magnetic Jet Cap over the white pegs on Retainer Plate in pedicure bowl so that the banana plug is at the top.

Gulfstream warrants to the original purchaser that the new pedicure spa will be free from defect during the Standard Warranty Period (listed below). The shipping date and the uniquely-coded Serial Number on the back of each spa chair will justify the start of the warranty period for the product. The warranty is null and void if the pedicure spa is taken from its initial place of installation, or it is not installed in accordance with federal, state or local codes and ordinances. Also, this warranty does not apply if the pedicure spa has been subject to misapplication, improper installation or maintenance, negligence, improper cleaning or other circumstances beyond Gulfstream's control.

Warranty

1. Limited Three(3) Years warranty on Spa Shell.
2. Limited One(1) Year warranty on the Whirlpool Pump.
3. Limited One(1) Year warranty on the Clean Jet.
4. Limited One(1) Year warranty on the Glass Bowl.
5. Limited One(1) Year Parts-Only warranty which covers the Hydraulic System, Discharge Pump, Massage System and All Electrical Components.
6. Gulfstream will pay standard shipping charges on all replacement parts during the first 90 days of the stated Warranty Period. After 90 days the consumer is responsible for all labor and shipping costs incurred.

Exclusions

1. Damage to pump parts and/or motor parts due to obstruction in plumbing lines etc.
2. Staining, fading or discoloration of plastic surfaces due to exposure and/or the use of harmful cleaning agents or chemicals.
3. Staining, fading or discoloration caused by improper or poor water additives not related to the maintenance of proper water are not covered by this warranty.
4. Staining, fading or discoloration of the seat, armrests or footrests.
5. Freight damage, misuse, neglect, accident, natural disaster and abuse.
6. Unauthorized repairs.

Service

1. The Dealer shall forward all warranty-related matters to our Customer Service Department.
2. Serial Numbers and Original Invoice must accompany all warranty claims.
3. Customers are responsible for shipping defective parts back to Gulfstream. These parts must be packaged correctly in order to protect against any further damage.
4. All parts are to be shipped by UPS Ground Service, average 2-5 days.
5. All defective parts must be shipped back to Gulfstream within 30 days of receiving the new replacement parts or warranty will be void.
6. Any warranty claim that cannot be determined over the phone, the customer must send photos and original invoice directly to Gulfstream before any repairs can be performed.
7. Any service performed on the product without Gulfstreams authorization will also void the Warranty.
8. Each service call from the customer will be assigned a Claim Number. The Claim Number will stay open until the problem is resolved.

No dealer or other person has any authority to bind Gulfstream Inc. to changes or additions to this warranty or its products. Accordingly, Gulfstream Inc. Is not responsible for such warranties or representations.